

AINA

Sillon comedor - Dining Armchair

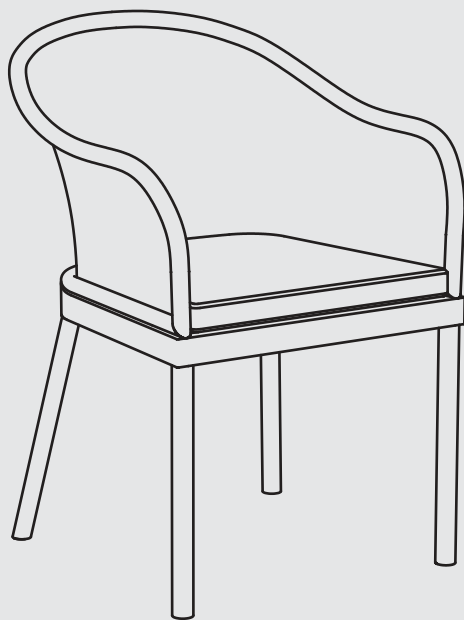

Mantenimiento / Care

- Lavar con agua dulce regularmente y secar con paño suave.
- Evite aguas calcáreas.
- Evite los depósitos de sal y polvo.
- No emplee productos químicos ni abrasivos.
- Wash with fresh water regularly and dry with a soft cloth.
- Avoid calcareum water.
- Remove salt and dust deposits.
- Don't clean with chemicals or abrasive products.

AINA

Sillon comedor - Dining Armchair

IMPORTANTE, CONSERVAR PARA FUTURAS CONSULTAS: LEER CON ATENCIÓN
IMPORTANT, RETAIN FOR FUTURE REFERENCE: READ CAREFULLY

Herramientas necesarias/Required Tools:

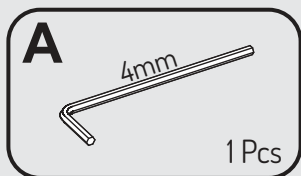

Partes/Parts

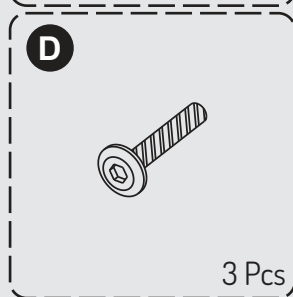
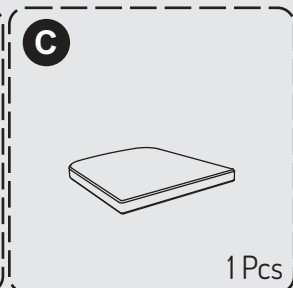
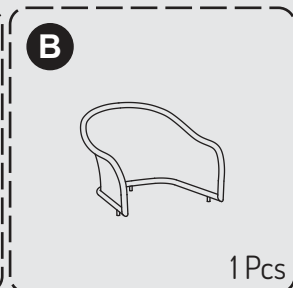
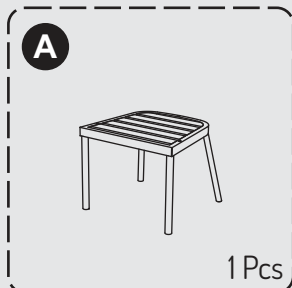

Montaje/Assembly

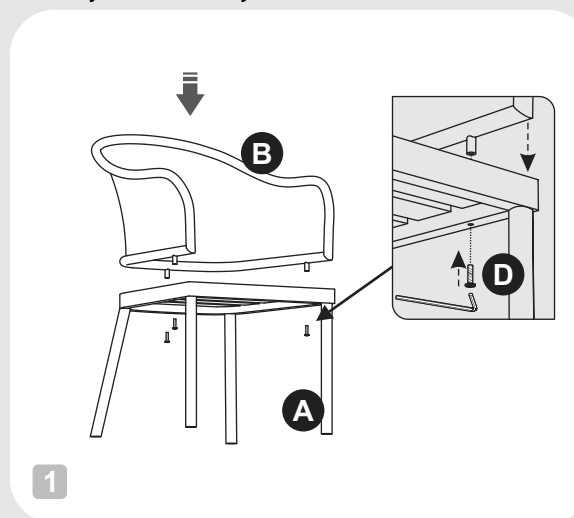

Mantenimiento / Care

- Lavar con agua dulce regularmente y secar con paño suave.
- Evite aguas calcáreas.
- Evite los depósitos de sal y polvo.
- No emplee productos químicos ni abrasivos.
- Wash with fresh water regularly and dry with a soft cloth.
- Avoid calcareum water.
- Remove salt and dust deposits.
- Don't clean with chemicals or abrasive products.

Uso/ Use

- Doméstico exclusivamente.
- Aconsejado bajo porche.
- Domestic only.
- It is recommended undercover use.

MARROD ACTIVOS, S.L.
C/Gaudí 47
29680 Estepona
Málaga, España
www.ns-international.info

